

# ERCOLE "G"

VERSIONE : 01

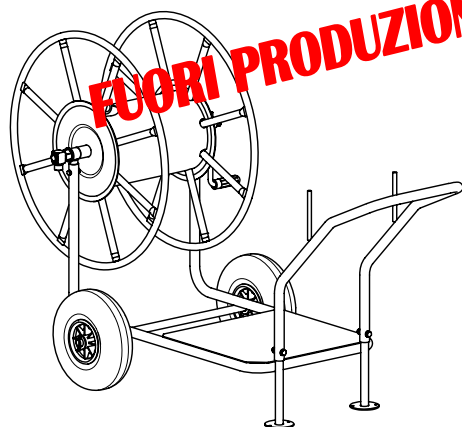

**FUORI PRODUZIONE / OUT OF PRODUCTION**

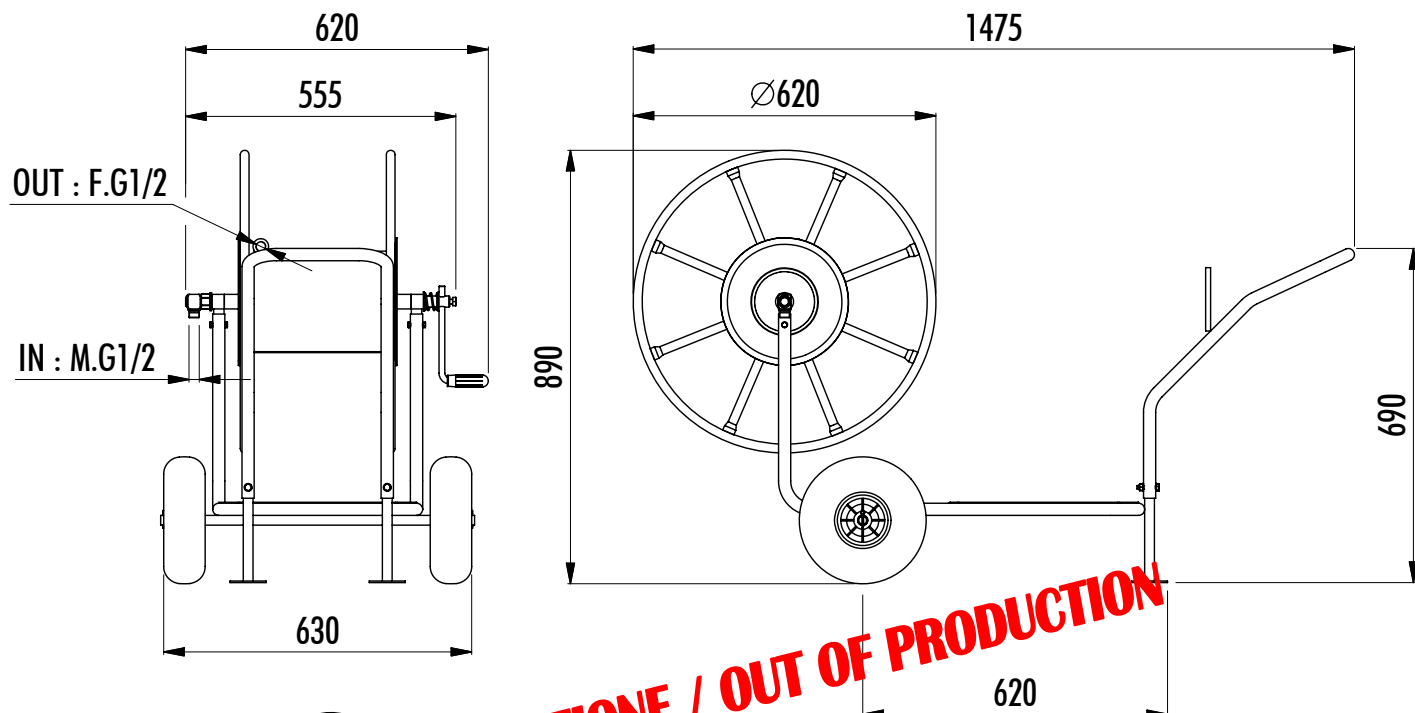
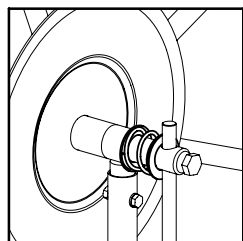

Molla frizione  
Clutch spring

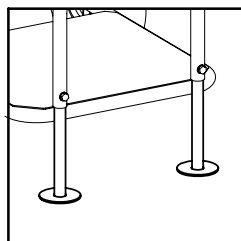

Piedini anti sprofondamento  
Anti-sinking footsies

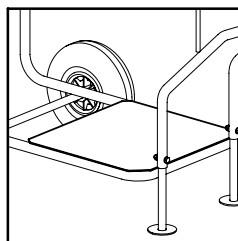

Base per motopompa  
Pump set support

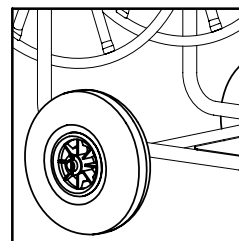

Ruote gonfiabili  
Pumpable wheels

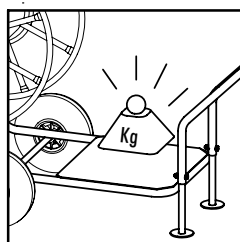

Telaio rinforzato  
Reinforced chassis

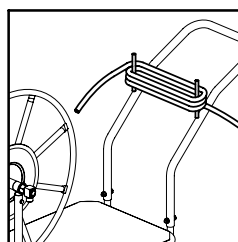

Supporto tubo di alimentazione  
Hose rest

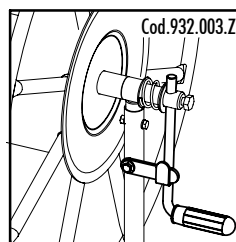

Bloccaggio rullo (optional)  
Reel stop (optional)

Cod.932.003.Z

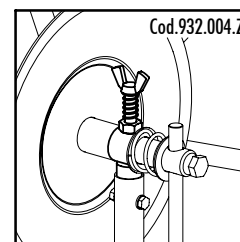

Frizione (optional)  
Clutch (optional)

Cod.932.004.Z

Codice verniciato Code painted	BAR	Lunghezza e diametro tubo consigliati Recommended hose length and diameter	Metri di tubo riavvolgibili calcolati su diversi diametri esterni in pollici e millimetri Metres of hose, with can be rewinded, calculated on different external diameters in inches and millimeters								Peso Weight	OPTIONAL		
			Ø 1/4		Ø 5/16		Ø 3/8		Ø 1/2			Bloccaggio rullo Reel stop	Frizione Clutch	
			14	15	16	17	18	19	20	21				22
250.350.M	250	150 m - Ø 1/2	/	/	/	238	201	192	170	162	130	24 Kg	932.007.Z	932.008.Z