

ERCOLE "S"

VERSIONE : 02

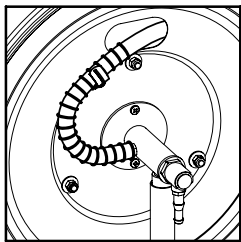

Montaggio tubo facilitato
Easily installable hose

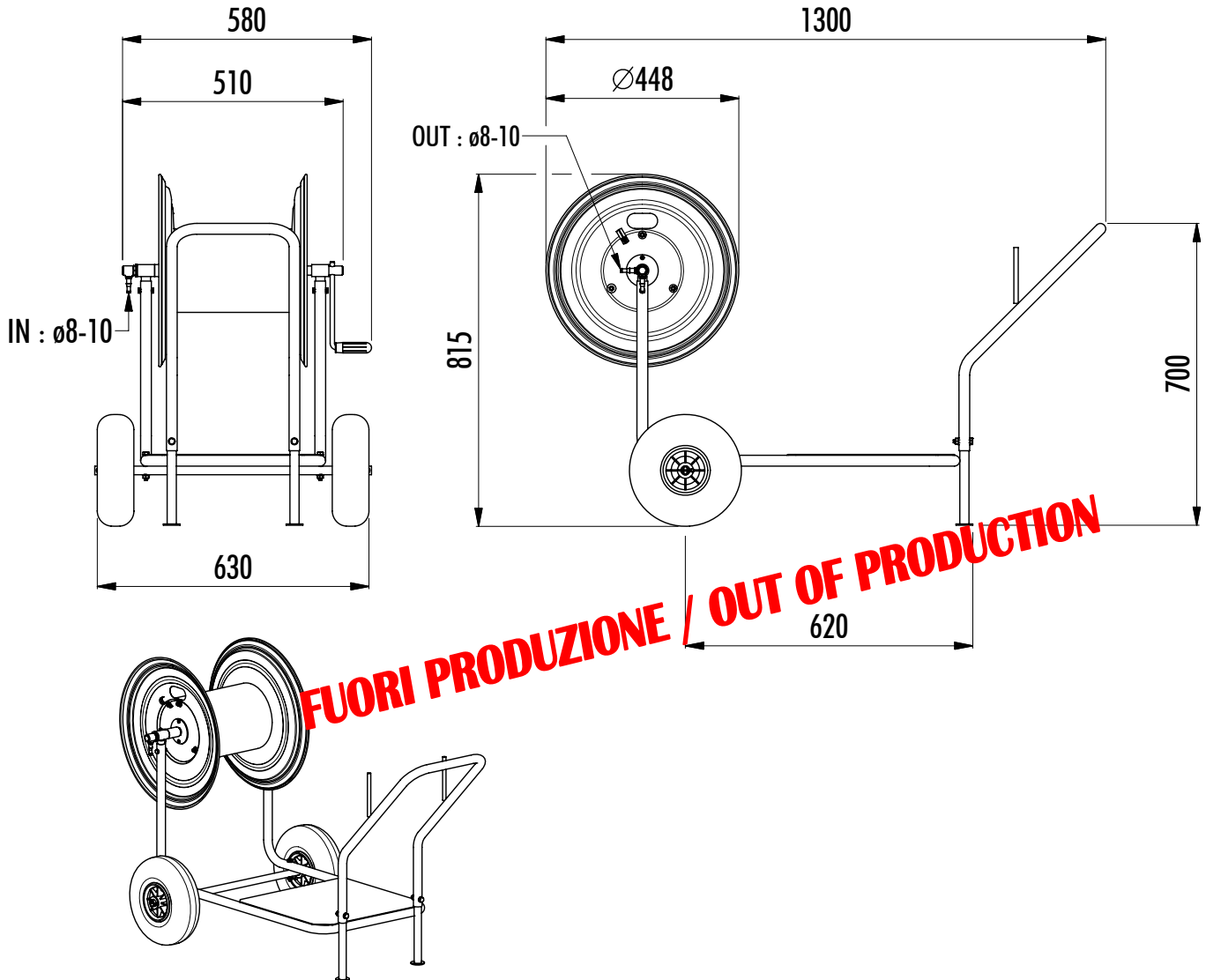
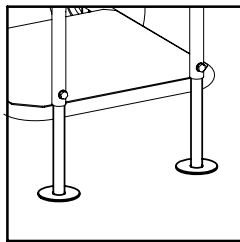

Piedini anti sprofondamento
Anti-sinking footsies

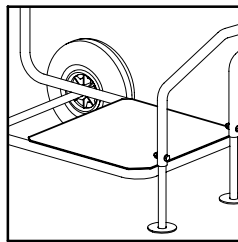

Base per motopompa
Pump set support

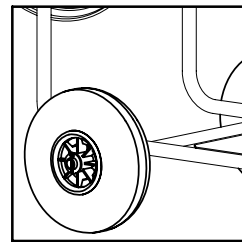

Ruote gonfiabili
Pumpable wheels

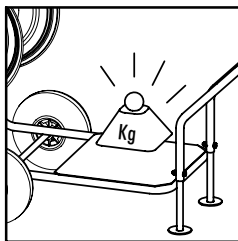

Telaio rinforzato
Reinforced chassis

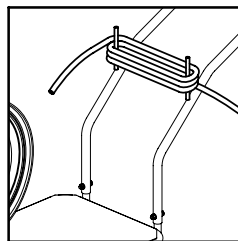

Supporto tubo di alimentazione
Hose rest

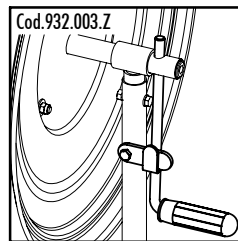

Bloccaggio rullo (optional)
Reel stop (optional)

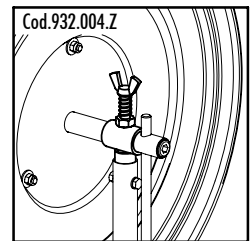

Frizione (optional)
Clutch (optional)

Codice verniciato Code painted	BAR	Lunghezza e diametro tubo consigliati Recommended hose length and diameter	Metri di tubo riavvolgibili calcolati su diversi diametri esterni in pollici e millimetri Metres of hose, witch can be rewinded,calculated on different external diameters in inches and millimeters										Peso Weight	OPTIONAL	
			Ø 1/4		Ø 5/16		Ø 3/8		Ø 1/2		Bloccaggi rullo Reel stop	Frizione Clutch			
			14	15	16	17	18	19	20	21				22	
250.100.M	50	100 m - Ø 10x18	172	134	130	109	100	95	77	70	65	15 Kg	932.003.Z	932.004.Z	